

DE	Gebruiksaanleitung / Montageanleitung	2
FR	Mode d'emploi / Instructions de montage	2
EN	Instructions for use / assembly instructions	3
IT	Istruzioni per l'uso / Istruzioni per Installazione	3
ES	Modo de empleo / Instrucciones de montaje	4
NL	Gebruiksaanwijzing / Handleiding	4
DK	Brugsanvisning / Monteringsvejledning	5
PT	Instruções para uso / Manual de Instalação	5
PL	Instrukcja obsługi / Instrukcja montażu	6
CS	Návod k použití / Montážní návod	6
SK	Návod na použitie / Montážny návod	7
ZH	用户手册 / 组装说明	7
RU	Руководство пользователя / Инструкция по монтажу	8
HU	Használati útmutató / Szerelési útmutató	8
FI	Käyttöohje / Asennusohje	9
SV	Bruksanvisning / Monteringsanvisning	9
LT	Vartotojo instrukcija / Montavimo instrukcijos	10
HR	Upute za uporabu / Uputstva za instalaciju	10
TR	Kullanım kılavuzu / Montaj kılavuzu	11
RO	Manual de utilizare / Instrucțiuni de montare	11
EL	Οδηγίες χρήσης / Οδηγία συναρμολόγησης	12
SL	Navodilo za uporabo / Navodila za montažo	12
ET	Kasutusjuhend / Paigaldusjuhend	13
LV	Lietošanas pamācība / Montāžas instrukcija	13
SR	Uputstvo za upotrebu / Uputstvo za montažu	14
NO	Bruksanvisning / Montasjeveiledning	14
BG	Инструкция за употреба / Ръководство за монтаж	15
SQ	Udhëzuesi i përdorimit / Udhëzime rreth montimit	15
AR	دليل الاستخدام / تعليمات التجميع	16

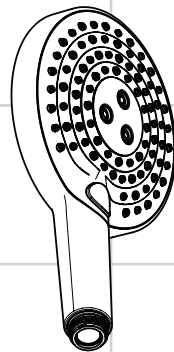

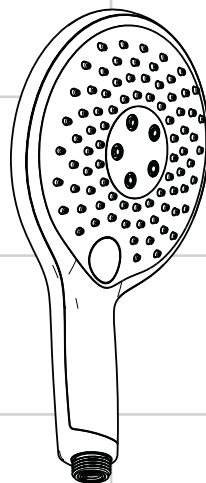



Raindance Select S 120
26530000 / 26530400



Raindance Select S 150
28587000 / 28587400



Sicherheitshinweise

-  Kinder, sowie Erwachsene mit körperlichen, geistigen und / oder sensorischen Einschränkungen dürfen nicht unbeaufsichtigt das Duschsystem benutzen. Personen die unter Alkohol- oder Drogeneinfluss stehen, dürfen das Duschsystem nicht benutzen.
-  Bei der Montage müssen zur Vermeidung von Quetsch- und Schnittverletzungen Handschuhe getragen werden.
-  Der Kontakt der Brausestrahlen mit empfindlichen Körperstellen (z. B. Augen) muss vermieden werden. Es muss ein ausreichender Abstand zwischen Brause und Körper eingehalten werden.
-  Die Brause darf nur zur Bade-, Hygiene- und Körperreinigungszwecke eingesetzt werden.

Montagehinweise

Der vormontierte Filtereinsatz muss verwendet werden, um den Normdurchfluss der Handbrause zu gewährleisten und um Schmutzeinspülungen aus dem Leitungsnetz zu vermeiden. Schmutzeinspülungen können die Funktion beeinträchtigen und/oder zu Beschädigungen an Funktionsteilen der Handbrause führen, für hieraus ergebende Schäden haftet Hansgrohe nicht

Technische Daten

Betriebsdruck: max. 0,6 MPa
 Empfohlener Betriebsdruck: 0,15 - 0,4 MPa
 (1 MPa = 10 bar = 147 PSI)
 Heißwassertemperatur: max. 60°C
 Thermische Desinfektion: max. 70°C / 4 min
 Das Produkt ist ausschließlich für Trinkwasser konzipiert!

Symbolerklärung



Maße (siehe Seite 18)



Durchflussdiagramm (siehe Seite 18)



Prüfzeichen (siehe Seite 18)



Bedienung (siehe Seite 17)







Reinigung (siehe Seite 20) und beiliegende Broschüre



Serviceteile (siehe Seite 17)

Consignes de sécurité

-  Il est interdit aux enfants ainsi qu'aux adultes ayant des insuffisantes physiques, psychiques et/ou motoriques d'utiliser la douche sans surveillance. De même, il est interdit à des personnes sous influence d'alcool ou de drogues d'utiliser la douche.
-  Lors du montage, porter des gants de protection pour éviter toute blessure par écrasement ou coupure.
-  Éviter le contact du jet de la douchette avec les parties sensibles du corps (telles par ex. que les yeux). Veiller à respecter un écart suffisant entre la douchette et le corps
-  La douchette ne doit servir qu'à se doucher, à se nettoyer et à pratiquer une hygiène corporelle.

Instructions pour le montage

La garniture filtrante prémontée doit être utilisée pour garantir le débit normal de la douchette et éviter l'infiltration de saletés provenant du réseau de conduites. Ces infiltrations de saletés risquent de porter préjudice et/ou d'endommager les éléments fonctionnels de la douchette et n'entrent pas dans le cadre de la responsabilité de Hansgrohe.

Informations techniques

Pression de service autorisée: max. 0,6 MPa
 Pression de service conseillée: 0,15 - 0,4 MPa
 (1 MPa = 10 bar = 147 PSI)
 Température d'eau chaude: max. 60°C
 Désinfection thermique: max. 70°C / 4 min
 Le produit est exclusivement conçu pour de l'eau potable!

Description du symbole



Dimensions (voir page 18)



Diagramme du débit (voir page 18)



Classification acoustique et débit (voir page 18)



Instructions de service (voir page 17)



Nettoyage (voir page 20) et brochure ci-jointe



Pièces détachées (voir pages 17)





Montage
siehe Seite 17



Montage
voir page 17



Safety Notes

-  Children as well as adults with physical, mental and/or sensoric impairments must not use this shower system without proper supervision. Persons under the influence of alcohol or drugs are prohibited from using this shower system.
-  Gloves should be worn during installation to prevent crushing and cutting injuries.
-  Do not allow the streams of the shower touch sensitive body parts (such as your eyes). An adequate distance must be kept between the shower and you.
-  The shower may only be used for bathing, hygiene and body cleansing purposes.

Installation Instructions







The premounted filter insert must be used to ensure a normal flow of the shower and to prevent dirt from entering through the pipes. Dirt entering can affect the function and/or lead to damages to the shower. Hansgrohe will not be held liable for this type of damage.

Technical Data

Operating pressure:	max. 0,6 MPa
Recommended operating pressure: (1 MPa = 10 bar = 147 PSI)	0,15 - 0,4 MPa
Hot water temperature:	max. 60°C
Thermal disinfection:	max. 70°C / 4 min

The product is exclusively designed for drinking water!





Symbol description

-  **Dimensions** (see page 18)
-  **Flow diagram** (see page 18)
-  **Test certificate** (see page 18)
-  **Operation** (see page 17)
-  **Cleaning** (see page 20) and enclosed brochure
-  **Spare parts** (see page 17)

Assembly
see page 17



Indicazioni sulla sicurezza

-  I bambini e gli adulti affetti da menomazioni fisiche, psichiche e/osenoriali devono utilizzare il sistema della doccia solo sotto la supervisione di una persona responsabile.
-  Durante il montaggio, per evitare ferite da schiacciamento e da taglio bisogna indossare guanti protettivi.
-  Bisogna evitare il contatto fra il getto della doccia e parti del corpo delicate (ad es. gli occhi). Fra il soffione ed il corpo va mantenuta una distanza sufficiente.
-  La doccia deve essere impiegata solo per il bagno e utilizzo igienico e pulizia del corpo.

Istruzioni per il montaggio







L'inserto filtrante premontato deve essere utilizzato per garantire il flusso normale della doccia e per evitare risciacqui di sporcizia dalla rete idrica. Risciacqui di sporcizia possono pregiudicare la funzione e/o danneggiare parti funzionali della doccia. Per danni risultanti da ciò non risponde la Hansgrohe

Dati tecnici

Pressione d'uso:	max. 0,6 MPa
Pressione d'uso consigliata: (1 MPa = 10 bar = 147 PSI)	0,15 - 0,4 MPa
Temperatura dell'acqua calda:	max. 60°C
Disinfezione termica:	max. 70°C / 4 min

Il prodotto è concepito esclusivamente per acqua potabile!





Descrizione simbolo

-  **Ingombri** (vedi pagg. 18)
-  **Diagramma flusso** (vedi pagg. 18)
-  **Segno di verifica** (vedi pagg. 18)
-  **Procedura** (vedi pagg. 17)
-  **Pulitura** (vedi pagg. 20) e brochure allegata
-  **Parti di ricambio** (vedi pagg. 17)

Montaggio
vedi pagg. 17



Indicaciones de seguridad

-  Niños, así como adultos con limitaciones corporales, mentales y/o sensoriales no deben utilizar el sistema de duchas sin vigilancia. Personas que se encuentran bajo el efecto de alcohol o drogas, no deben utilizar el sistema de duchas.
-  Durante el montaje deben utilizarse guantes para evitar heridas por aplastamiento o corte.
-  Debe evitarse el contacto del chorro del pulverizador con partes sensibles del cuerpo (por ej. ojos). Debe mantenerse una distancia suficiente entre pulverizador y cuerpo.
-  La roseta de ducha solo debe utilizarse para fines de baño, higiene y limpieza corporal.







Indicaciones para el montaje

El inserto de filtro premontado debe utilizarse para garantizar el caudal normado de la ducha manual y evitar que penetre suciedad procedente de la red de conducción. La suciedad puede limitar el funcionamiento y provocar daños en partes funcionales de la ducha manual, Hansgrohe no asumirá ninguna responsabilidad por los daños que de ello se deriven

Datos técnicos





Presión en servicio: max. 0,6 MPa
 Presión recomendada en servicio: 0,15 - 0,4 MPa
 (1 MPa = 10 bar = 147 PSI)
 Temperatura del agua caliente: max. 60°C
 Desinfección térmica: max. 70°C / 4 min
 El producto ha sido concebido exclusivamente para agua potable.

Descripción de símbolos

-  **Dimensiones** (ver página 18)
-  **Diagrama de circulación** (ver página 18)
-  **Marca de verificación** (ver página 18)
-  **Manejo** (ver página 17)
-  **Limpiar** (ver página 20) y folleto anexo
-  **Repuestos** (ver página 17)

Montaje
ver página 17

Veiligheidsinstructies

-  Kinderen en volwassenen met lichamelijke, geestelijke en/of sensorische beperkingen mogen het douchesysteem niet zonder toezicht gebruiken. Personen onder invloed van alcohol of drugs mogen het douchesysteem niet gebruiken.
-  Bij de montage moeten ter voorkoming van knel- en snijwonden handschoenen worden gedragen.
-  Het contact van de douchestraal met gevoelige lichaamsdelen (bijv. ogen) moet worden voorkomen. Er moet voldoende afstand tussen douche en lichaam aangehouden worden.
-  De douche uitsluitend toepassen in badkamers ten behoeve van lichaamsreiniging.







Montage-instructies

Het voorgemonteerde filterelement moet gebruikt worden om het normdebiet van de handdouche te garanderen en om vuil uit de waterleiding te weren. Vuil uit de waterleiding kan de werking negatief beïnvloeden en / of de handdouche beschadigen; voor daaruit voortvloeiende schade is Hansgrohe niet aansprakelijk.

Technische gegevens

Werkdruk: max. 0,6 MPa
 Aanbevolen werkdruk: 0,15 - 0,4 MPa
 (1 MPa = 10 bar = 147 PSI)
 Temperatuur warm water: max. 60°C
 Thermische desinfectie: max. 70°C / 4 min
 Het product is uitsluitend ontworpen voor drinkwater!

Symboolbeschrijving





-  **Maten** (zie blz. 18)
-  **Doorstroombiagram** (zie blz. 18)
-  **Keurmerk** (zie blz. 18)
-  **Bediening** (zie blz. 17)
-  **Reinigen** (zie blz. 20) en bijgevoegde brochure
-  **Service onderdelen** (zie blz. 17)

Montage
zie blz. 17





Sikkerhedsanvisninger

-  Børn som også voksne med fysiske, mentale og / eller sensoriske begrænsninger må ikke bruge brusersystemet uden opsyn. Personer som er under indflydelse af alkohol eller narkotika må ikke bruge brusersystemet.
-  Ved monteringen skal der bruges handsker for at undgå kvæstelser og snitsår.
-  Bruserstrålens kontakt med sensitive områder (f.eks. øjne) skal undgås. Der skal være en tilstrækkelig afstand mellem bruseren og kroppen.
-  Bruseren må kun bruges til at bruse, til hygiejne og rengøring af kroppen.







Monteringsanvisninger

For at garantere håndbruserens standardgennemstrømning og for at undgå tilsmudsninger fra ledningsnettet, skal man bruge den formonterede filterindsats. Tilsmudsningen kan påvirke funktionen og/eller føres til skader på håndbruserens funktionskomponenter. Hans Grohe er ikke ansvarligt for heraf resulterende skader

Tekniske data

Driftstryk: max. 0,6 MPa
 Anbefalet driftstryk: 0,15 - 0,4 MPa
 (1 MPa = 10 bar = 147 PSI)
 Varmvandstemperatur: max. 60 °C
 Termisk desinfektion: max. 70 °C / 4 min
 Produktet er udelukkende beregnet til drikkevand!





Symbolbeskrivelse

-  **Målene** (se s. 18)
-  **Doorstroombiagram** (se s. 18)
-  **Godkendelse** (se s. 18)
-  **Brugsanvisning** (se s. 17)
-  **Rengøring** (se s. 20) og vedlagt brochure
-  **Reservevedele** (se s. 17)

Montering
se s. 17



Avisos de segurança

-  Crianças e adultos com deficiências motoras, mentais e/ou sensoriais não podem utilizar o sistema de duche sem monitorização. Pessoas que estejam sob a influência de álcool ou drogas não podem utilizar o sistema de duche.
-  Durante a montagem devem ser utilizadas luvas de protecção, de modo a evitar ferimentos resultantes de entalamentos e de cortes.
-  Deve-se evitar o contacto dos jactos de água com partes do corpo sensíveis (p. ex. olhos). É necessário manter uma distância suficiente entre o chuveiro e o corpo.
-  O chuveiro só pode ser utilizado para fins de higiene pessoal.







Avisos de montagem

O elemento filtrante pré-montado tem que ser utilizado para garantir o fluxo normalizado do chuveiro de mão e para evitar a entrada de sujidade proveniente da rede. A sujidade proveniente da rede pode influenciar o funcionamento e/ou provocar danos nas peças funcionais do chuveiro de mão. A Hansgrohe não se responsabiliza por danos daí resultantes.

Dados Técnicos

Pressão de funcionamento: max. 0,6 MPa
 Pressão de func. recomendada: 0,15 - 0,4 MPa
 (1 MPa = 10 bar = 147 PSI)
 Temperatura da água quente: max. 60 °C
 Desinfecção térmica: max. 70 °C / 4 min
 Este produto foi única e exclusivamente concebido para água potável!

Descrição do símbolo

-  **Medidas** (ver página 18)
-  **Fluxograma** (ver página 18)
-  **Marca de controlo** (ver página 18)
-  **Funcionamento** (ver página 17)
-  **Limpeza** (ver página 20) e brochura em anexo
-  **Peças de substituição** (ver página 17)

Montagem
ver página 17

**! Wskazówki bezpieczeństwa**

- △ Zarówno dzieci, jak i dorośli z fizycznymi, psychicznymi i/lub sensorycznymi ograniczeniami nie mogą korzystać z prysznica bez opieki. Osoby znajdujące się pod wpływem alkoholu lub narkotyków nie mogą korzystać z prysznica.
- △ Aby uniknąć zranień, takich jak zgniecenia czy przecięcia, podczas montażu należy nosić rękawice.
- △ Należy unikać kontaktu strumienia wyływającego z głowicy z wrażliwymi częściami ciała (np. oczami). Należy zachowywać odpowiednią odległość pomiędzy głowicą a ciałem.
- △ Prysznic może być używany tylko do kąpieli, higieny i czyszczenia ciała.

Wskazówki montażowe

Należy użyć zamontowaną uprzednio wkładkę filtra, aby zapewnić przepisywany przepływ przez prysznic ręczny i zapobiec przedostawaniu się zanieczyszczeń z instalacji sieciowej. Przedostające się zanieczyszczenia mogą mieć negatywny wpływ na działanie i/lub prowadzić do usterek w działaniu elementów prysznica ręcznego; za powstałe z tego tytułu szkody firma Hansgrohe nie ponosi odpowiedzialności.

Dane techniczne

Ciśnienie robocze:	maks. 0,6 MPa
Zalecane ciśnienie robocze:	0,15 - 0,4 MPa
(1 MPa = 10 bary = 147 PSI)	
Temperatura wody gorącej:	maks. 60 °C
Dezynfekcja termiczna:	maks. 70 °C / 4 min
Produkt stworzono wyłącznie do wody pitnej!	

Opis symbolu

-  **Wymiary** (patrz strona 18)
-  **Schemat przepływu** (patrz strona 18)
-  **Znak jakości** (patrz strona 18)
-  **Obsługa** (patrz strona 17)
-  **Czyszczenie** (patrz strona 20) i dołączona broszura
-  **Części serwisowe** (patrz strona 17)

! Bezpečnostní pokyny

- △ Děti a dospělí osoby s tělesným, duševním a / nebo smyslovým postižením nesmí sprchový systém používat bez dozoru. Osoby pod vlivem alkoholu nebo drog nesmí sprchový systém používat.
- △ Pro zabránění řezným zraněním a pohmožděním je nutné při montáži nosit rukavice.
- △ Je nutné zabránit kontaktu vodních paprsků sprchy s měkkými částmi těla (např. očima). Je nutné dodržovat dostatečný odstup mezi sprchou a tělem.
- △ Sprcha smí být používána pouze za účelem koupání a tělesné hygieny.

Pokyny k montáži

Pro zaručení normálního průtoku ruční sprchy a zabránění vzniku usazenin z přírodního vedení se musí použít předmontovaná filtrační vložka. Usazeniny nečistot mohou ovlivnit funkci sprchy a/nebo vést k poškození funkčních dílů sprchy. Za takto vzniklé škody firma Hansgrohe neručí.

Technické údaje

Provozní tlak:	max. 0,6 MPa
Doporučený provozní tlak:	0,15 - 0,4 MPa
(1 MPa = 10 bar = 147 PSI)	
Teplota horké vody:	max. 60 °C
Teplná desinfekce:	max. 70 °C / 4 min
Výrobky Hansgrohe jsou vhodné pro přímý kontakt s pitnou vodou.	

Popis symbolů

-  **Rozměry** (viz strana 18)
-  **Diagram průtoku** (viz strana 18)
-  **Zkušební značka** (viz strana 18)
-  **Ovládání** (viz strana 17)
-  **Čištění** (viz strana 20) a přiložená brožura
-  **Servisní díly** (viz strana 17)

Montáž**patrz strona 17****Montáž****viz strona 17**



Bezpečnostné pokyny

- △ Sprchovací systém nesmú bez dozoru používať deti, ako aj dospelé osoby s telesným, duševným a/alebo zmyslovým postihnutím. Sprchovací systém nesmú používať ani osoby, ktoré sú pod vplyvom alkoholu alebo drog.
- △ Pri montáži musíte nosiť rukavice, aby ste predišli pomliaždeninám a rezným poraneniam.
- △ Vyhýbajte sa kontaktu vodného lúča sprchy s citlivými miestami tela (napr. oči). Dodržiavajte dostatočnú vzdialenosť medzi sprchou a telom.
- △ Sprcha sa smie používať len na účely kúpania a telesnej hygieny.







Pokyny pre montáž

Predmontovaná filtračná vložka sa musí použiť, aby sa zaručil normovaný prietok ručnej sprchy a odstránili naplaveniny nečistôt z rozvodnej siete. Naplaveniny nečistôt môžu ovplyvniť funkčnosť a/alebo môžu viesť k poškodeniam funkčných dielov ručnej sprchy, pričom za takto spôsobené škody spoločnosť Hansgrohe neručí.

Technické údaje

Prevádzkový tlak: max. 0,6 MPa
 Doporučený prevádzkový tlak: 0,15 - 0,4 MPa
 (1 MPa = 10 bar = 147 PSI)
 Teplota teplej vody: max. 60°C
 Termická dezinfekcia: max. 70°C / 4 min
 Výrobok je koncipovaný výhradne pre pitnú vodu!

Popis symbolov

-  **Rozmery** (viď strana 18)
-  **Diagram prietoku** (viď strana 18)
-  **Osvedčenie o skúške** (viď strana 18)
-  **Obsluha** (viď strana 17)
-  **Čištění** (viď strana 20) a priložená brožúra
-  **Servisné diely** (viď strana 17)

安全技巧

- △ 不得让儿童和肢体、精神和/或意识有障碍的成人在不受监管的情况下使用淋浴系统。受酒精或毒品影响的人员不得使用淋浴系统。
- △ 装配时为避免挤压和切割受伤，必须戴上手套。
- △ 必须避免让身体敏感部位（如眼睛）接触到莲蓬头喷水。必须保持莲蓬头与人头之间有足够的距离。
- △ 该莲蓬头仅允许作淋浴、卫生保健和身体清洁目的使用。







安装提示

必须使用预装配好的过滤器芯，以保障手持花洒达到标准水流量并避免从管网中冲出污物。污物可损害功能和/或导致损坏手持花洒的功能件，对由此所产生的损害汉斯格雅公司将不承担责任。

技术参数

工作压力: 最大 0,6 MPa
 推荐工作压力: 0,15 - 0,4 MPa
 (1 MPa = 10 bar = 147 PSI)
 热水温度: 最大 60°C
 热力消毒: 最大 70°C / 4 分钟
 该产品专为饮用水设计！

符号说明

-  **大小** (参见第 18 页)
-  **流量示意图** (参见第 18 页)
-  **检验标记** (参见第 18 页)
-  **操作** (参见第 17 页)
-  **清洗** (参见第 20 页) 并附有小手册
-  **备用零件** (参见第 17 页)

Montáž
viď strana 17



安装
参见第 17 页

**⚠ Указания по технике безопасности**

- ⚠ Дети, а также взрослые с физическими, умственными и/или сенсорными недостатками должны пользоваться душевой системой только под присмотром. Запрещается пользоваться душевой системой в состоянии алкогольного или наркотического опьянения.
- ⚠ Во время монтажа следует надеть перчатки во избежание прищемления и порезов.
- ⚠ Не допускайте попадания струи воды из разбрызгивателя на чувствительные части тела (например, на глаза). Разбрызгиватель следует устанавливать на достаточном расстоянии от тела.
- ⚠ Источник разбрызгивания разрешается использовать только в гигиенических целях для принятия ванны и личной гигиены.

Указания по монтажу

Необходимо установить предварительно смонтированный фильтрующий элемент, чтобы обеспечить нормальный поток для ручного душа и предотвратить попадание загрязнений из канализационной сети. Попадание загрязнений ухудшает работу и/или приводит к повреждению функциональных деталей ручного душа. Компания Hansgrohe не несет ответственности за ущерб, причиненный в результате несоблюдения этого требования

Технические данные

Рабочее давление: не более 0,6 МПа
 Рекомендуемое рабочее давление: 0,15 - 0,4 МПа
 (1 МПа = 10 bar = 147 PSI)
 Температура горячей воды: не более 60°C
 Термическая дезинфекция: не более 70°C / 4 мин
 Изделие предназначено исключительно для питьевой воды!

Описание символов**Размеры** (см. стр. 18)**Схема потока** (см. стр. 18)**Знак технического контроля**
(см. стр. 18)**Эксплуатация** (см. стр. 17)**Очистка** (см. стр. 20) и прилагаемая брошюра**Комплект** (см. стр. 17)**⚠ Biztonsági utasítások**

- ⚠ Gyermekek, valamint testileg, szellemileg fogyatékos vagy érzékelésben korlátozott személyek nem használhatják felügyelet nélkül a zuhanyrendszert. Alkohol és kábítószer befolyása alatt álló személyek nem használhatják a zuhanyrendszert.
- ⚠ A szerelésnél a zúzódások és vágási sérülések elkerülése érdekében kesztyűt kell viselni.
- ⚠ Kerülni kell a zuhanyugár érintkezését érzékeny testrészekkel (pl. szemek). Be kell tartani a megfelelő távolságot a zuhanyfej és a test között.
- ⚠ A zuhanyt csak fürdő-higiéniai- és tisztítási célra szabad használni.

Szerelési utasítások

Az előre felszerelt szűrőbetétet kell használni a kézi zuhany szabvány átfolyásának biztosításához, és hogy elkerülje a szennyeződések befolyását a vezetékéből. A szennyeződések befolyásolhatják a működést és / vagy a kézi zuhany működő részeinek rongálódásához vezethetnek, az ebből származó károokért a Hansgrohe nem vállal felelőséget





Műszaki adatok

Üzemi nyomás: max. 0,6 MPa
 Ajánlott üzemi nyomás: 0,15 - 0,4 MPa
 (1 MPa = 10 bar = 147 PSI)
 Forróvíz hőmérséklet: max. 60°C
 Termikus fertőtlenítés: max. 70°C / 4 perc
 A terméket kizárólag ivóvízhez tervezték!

Szimbólumok leírása**Méretet** (lásd a 18. oldalon)**Átfolyási diagramm** (lásd a 18. oldalon)**Vizsgajel** (lásd a 18. oldalon)**Használat** (lásd a 17. oldalon)**Tisztítás** (lásd a 20. oldalon) és mellékelt brossúrával**Tartozékok** (lásd a 17. oldalon)**Монтаж**
см. стр. 17**Szerelés**
lásd a 17. oldalon



Turvallisuusohjeet

-  Lapset ja ruumiillisesti, henkisesti ja/tai aistillisesti rajoittuneet aikuiset eivät saa käyttää suihkujärjestelmää ilman valvontaa. Alkoholin tai huumeiden vaikutuksessa olevat henkilöt eivät saa käyttää suihkujärjestelmää.
-  Asennuksessa on käytettävä käsiineitä puristumien ja viiltojen aiheuttamien tapaturmien estämiseksi.
-  Suihkuveden kontaktia herkkien ruumiinosien (esim. silmien) kanssa on vältettävä. Suihkun ja vartalon välissä on oltava riittävä väli.
-  Suihkua saa käyttää vain kylpy-, hygienia ja kehonpuhdistustarkoituksiin.





Asennusohjeet

Esiasesennettua suodatinpatruunaa on käytettävä, jotta käsisuihkun normaali läpivirtaus on taattu ja likahiukkasten huuhtoutuminen vesijohtoverkostosta estyy. Likahiukkaskertymät voivat aiheuttaa toimintahäiriöitä ja/tai vahingoittaa käsisuihkun toiminnallisia osia, Hansgrohe ei vastaa näin syntyvistä vaurioista.

Tekniset tiedot

Käyttöpaine:	maks. 0,6 MPa
Suosittelut käyttöpaine:	0,15 - 0,4 MPa
(1 MPa = 10 bar = 147 PSI)	
Kuuman veden lämpötila:	maks. 60°C
Lämpödesinfektio:	maks. 70°C / 4 min
Tuote on suunniteltu käytettäväksi ainoastaan juomaveden kanssa!	

Säkerhetsanvisningar

-  Barn samt vuxna med fysiska, psykiska eller sensoriska funktionshinder får inte använda duschsystemet ensam. Personer som är påverkade av alkohol- eller droger får inte använda duschsystemet.
-  Handskar ska bäras under monteringsarbetet så att man kan undvika kläm- och skärskadorna werden.
-  Undvik att rikta duschstrålarna mot känsliga kroppsdelar (t. ex. ögonen. Det måste finnas ett tillräckligt stort avstånd mellan duschen och kroppen).
-  Duschen får bara användas till dusch-, bad- och personlig hygien.

Monteringsanvisningar

Den förmonterade filterinsatsen måste användas om normalflödet hos handduschen ska vara garanterat och för att undvika att smuts spolans in från ledningsnätet. Smuts som spolans in kan påverka funktionen och/eller leda till skador på funktionsdelar i handduschen. Hansgrohe fransäger sig allt ansvar för skador som kan härledas till detta.







Tekniska data

Driftstryck:	max. 0,6 MPa
Rek. driftstryck:	0,15 - 0,4 MPa
(1 MPa = 10 bar = 147 PSI)	
Varmvattentemperatur:	max. 60°C
Termisk desinfektio:	max. 70°C / 4 min
Produkten är enbart avsedd för dricksvatten!	

Merkin kuvaus

-  **Mitat** (katso sivu 18)
-  **Virtausdiagrammi** (katso sivu 18)
-  **Koestusmerkki** (katso sivu 18)
-  **Käyttö** (katso sivu 17)
-  **Puhdistus** (katso sivu 20) ja oheinen esite
-  **Varaosat** (katso sivu 17)

Simbolio aprašymas

-  **Mätten** (se sidan 18)
-  **Flödesschema** (se sidan 18)
-  **Testsigill** (se sidan 18)
-  **Hantering** (se sidan 17)
-  **Rengöring** (se sidan 20) och medföljande broschyr
-  **Reservdelar** (se sidan 17)

Asennus
katso sivu 17



Montering
se sidan 17



Saugumo technikos nurodymai

- △ Dušo sistema uždrausta naudotis vaikams, taip pat suaugusiems su fizine, dvasine negale ir (arba) sensorikos sutrikimais. Dušo sistema taip pat uždrausta naudotis asmenims, apsvaigusiems nuo alkoholio arba narkotikų.
- △ Apsaugai nuo užspaudimo ir įsijovimo montavimo metu mūvėkite pirštines.
- △ Būtina vengti dušo vandens srovės kontakto su jautriomis kūno vietomis (pvz., akimis). Todėl būtina laikytis tinkamo atstumo nuo dušo.
- △ Dušo galva naudojama tik maudymosi, higieniniai ir kūno švarinimo tikslais.

Montavimo instrukcija

Reikia naudoti sumontuotą filtro elementą, kad būtų užtikrintas norminis per rankinį dušą pratekantis srautas ir būtų išvengta teršalų, galinčių patekti iš vamzdyno. Patekę teršalai gali pakenkti veikimui ir/arba sugadinti veikiančias dalis. Už žalą, atsiradusią dėl šių priežasčių, bendrovė „Hansgrohe“ neatsako.

Techniniai duomenys

Darbinis slėgis: ne daugiau kaip 0,6 MPa
 Rekomenduojamas slėgis: 0,15 - 0,4 MPa
 (1 MPa = 10 barų = 147 PSI)
 Karšto vandens temperatūra: ne daugiau kaip 60°C
 Terminis dezinfekavimas: ne daugiau kaip 70°C / 4 min
 Produktas skirtas tik geriamajam vandeniui!

Sigurnosne upute

- △ Djeca, kao i tjelesno, mentalno i/ili senzorno hendikepirane odrasle osobe ne smiju se koristiti sustavom tuša bez nadzora. Osobe koje su pod utjecajem alkohola ili droga ne smiju se koristiti sustavom tuša.
- △ Prilikom montaže se radi sprječavanja prignječjenja i posjekotina moraju nositi rukavice.
- △ Mora se izbjegavati kontakt mlaza iz tuša s osjetljivim dijelovima tijela (npr. očima). Tijelo korisnika mora biti dovoljno udaljeno od tuša.
- △ Tuš se smije primjenjivati samo za kupanje, tuširanje i osobnu higijenu.

Upute za montažu

Mora se rabiti predmontirani filterski umetak, kako bi se regulirao protok vode kroz ručni tuš i izbjeglo unošenje prljavštine iz vodovoda. Prljavština može dovesti do djelomičnog ili potpunog oštećenja dijelova ručnog tuša. Za eventualna oštećenja uzrokovana prljavštinom proizvođač Hansgrohe nije odgovoran.

Tehnički podatci

Najveći dopušteni tlak: tlak 0,6 MPa
 Preporučeni tlak: 0,15 - 0,4 MPa
 (1 MPa = 10 bar = 147 PSI)
 Temperatura vruće vode: tlak 60°C
 Termička dezinfekacija: tlak 70°C / 4 min
 Proizvod je koncipiran isključivo za pitku vodu!

Simbolio aprašymas



Išmatavimai (žr. psl. 18)



Pralaidumo diagrama (žr. psl. 18)



Bandymo pažyma (žr. psl. 18)



Eksplotacija (žr. psl. 17)



Valymas (žr. psl. 20) ir pridėdama brošiūra



Atsarginės dalys (žr. psl. 17)

Opis simbola



Mjere (pogledaj stranicu 18)



Dijagram protoka (pogledaj stranicu 18)



Oznaka testiranja (pogledaj stranicu 18)



Upotreba (pogledaj stranicu 17)



Čišćenje (pogledaj stranicu 20) i priložena brošura



Rezervni djelovi (pogledaj stranicu 17)

Montavimas
žr. psl. 17



Sastavljanje
pogledaj stranicu 17



! Güvenlik uyarıları

- ! Bedensel, ruhsal ve/veya sensörük engelli çocuk ve yetişkinler gözetimsiz olarak duş sistemini kullanmamalıdır. Alkol veya uyuşturucu etkisinde olanlar duş sistemini kullanmamalıdır.
- ! Montaj esnasında ezilme ve kesilme gibi yaralanmaları önlemek için eldiven kullanılmalıdır.
- ! Püskürtme başlıklarının hassas organlara teması (örn. gözler) önlenmelidir. Püskürtücü ile beden arasında yeterli mesafe bırakılmalıdır.
- ! Su püskürtücü yalnızca banyo, hijyen ve yıkanma amaçları için kullanılabilir.

Montaj açıklamaları

Ön montajı yapılan filtre elemanı, el püskürtücüsünün standart akışını sağlamak ve hat şebekesindeki kirlenmeleri önlemek için kullanılmalıdır. Kirlenmeler işlevi olumsuz etkileyebilir ve/veya el püskürtücüsünün işlev parçalarında hasarlara yol açabilir. Hansgrohe, bundan dolayı kaynaklanabilecek hasarlara karşı sorumluluk üstlenmez.

Teknik bilgiler

İşletme basıncı:	azami 0,6 MPa
Tavsiye edilen işletme basıncı:	0,15 - 0,4 MPa
(1 MPa = 10 bar = 147 PSI)	
Sıcak su sıcaklığı:	azami 60°C
Termik dezenfeksiyon:	azami 70°C / 4 dak
Ürün sadece şebeke suyu için tasarlanmıştır!	

Simge açıklaması

-  **Ölçüleri** (Bakınız sayfa 18)
-  **Akış diyagramı** (Bakınız sayfa 18)
-  **Kontrol işareti** (Bakınız sayfa 18)
-  **Kullanımı** (Bakınız sayfa 17)
-  **Temizleme** (Bakınız sayfa 20) ve birlikte verilen broşür
-  **Yedek Parçalar** (Bakınız sayfa 17)

! Instrucțiuni de siguranță

- ! Copiii și adulții cu dizabilități corporale, mintale și senzoriale nu pot utiliza sistemul de duș nesupravegheați. De asemenea este interzisă utilizarea sistemului de duș de către persoane, care se află sub influența alcoolului sau a drogurilor.
- ! La montare utilizați mănuși pentru evitarea contuziunilor și tăierii mâinilor.
- ! Evitați contactul jetului de apă cu părțile de corp sensibile (de ex. ochii). Țineți dușul la o distanță corespunzătoare de corp.
- ! Dușul poate fi utilizat doar în scopuri de spălare, igienizare și de întreținere a igienei corporale.







Instrucțiunile de montare

Cartușul de filtru premontat se va utiliza pentru asigurarea debitului normal al telefonului de duș și pentru evitarea penetrării impurităților din rețeaua de apă. Aceste impurități pot afecta funcționarea dușului și/sau pot cauza deteriorarea elementelor funcționale ale telefonului de duș, firma Hansgrohe nu-și asumă răspunderea pentru daunele cauzate de aceste impurități

Date tehnice

Presiune de funcționare:	max. 0,6 MPa
Presiune de funcționare recomandată:	0,15 - 0,4 MPa
(1 MPa = 10 bar = 147 PSI)	
Temperatura apei calde:	max. 60°C
Dezinfecție termică:	max. 70°C / 4 min
Produsul este destinat exclusiv pentru apă potabilă.	

Descrierea simbolurilor

-  **Dimensiuni** (vezi pag. 18)
-  **Diagrama de debit** (vezi pag. 18)
-  **Certificat de testare** (vezi pag. 18)
-  **Utilizare** (vezi pag. 17)
-  **Curățare** (vezi pag. 20) și broșura alăturată
-  **Piese de schimb** (vezi pag. 17)





Montaj
Bakınız sayfa 17



Montare
vezi pag. 17



Υποδειξεις ασφαλείας

-  Παιδιά ή ενήλικες με μειωμένες σωματικές, διανοητικές και/ή αισθητήριες ανεπάρκειες δεν επιτρέπεται να χρησιμοποιούν το σύστημα ντους χωρίς επιτήρηση. Άτομα υπό την επήρεια οινοπνεύματος ή ναρκωτικών δεν επιτρέπεται να χρησιμοποιούν σε καμία περίπτωση το
-  Για να αποφύγετε τραυματισμούς κατά τη συναρμολόγηση πρέπει να φοράτε γάντια.
-  Η επαφή δέσμης νερού του ντους με ευαίσθητες περιοχές του σώματος (π.χ. μάτια) πρέπει να αποφεύγεται. Διατηρείτε επαρκή απόσταση ανάμεσα στο ντους και το σώμα.
-  Το ντους επιτρέπεται να χρησιμοποιείται μόνο για το μπάνιο, τον καθαρισμό και την υγιεινή του σώματος.







Οδηγίες συναρμολόγησης

Το τοποθετημένο στοιχείο φίλτρου πρέπει να χρησιμοποιηθεί, για να διασφαλιστεί η αναγκαία ροή νερού του τηλεφώνου του ντους και να αποφευχθεί η εκροή ακαθαρσιών από το δίκτυο παροχής ύδατος. Η εκροή ακαθαρσιών μπορεί να επηρεάσει τη λειτουργία και/ή να προκαλέσει ζημιές σε λειτουργικά μέρη του τηλεφώνου του ντους, για τις οποίες η Hansgrohe δεν ευθύνεται.





Τεχνικά Χαρακτηριστικά

Λειτουργία πίεσης: έως 0,6 MPa
 Συνιστώμενη λειτουργία πίεσης: 0,15 - 0,4 MPa
 (1 MPa = 10 bar = 147 PSI)
 Θερμοκρασία ζεστού νερού: έως 60 °C
 Θερμική απολύμανση: έως 70 °C / 4 min
 Το προϊόν έχει σχεδιαστεί αποκλειστικά για πόσιμο νερό!

Περιγραφή συμβόλων

-  **Διαστάσεις** (βλ. σελίδα 18)
-  **Διάγραμμα ροής** (βλ. σελίδα 18)
-  **Σήμα ελέγχου** (βλ. σελίδα 18)
-  **Χειρισμός** (βλ. σελίδα 17)
-  **Καθαρισμός** (βλ. σελίδα 20) και συνημμένο φυλλάδιο
-  **Ανταλλακτικά** (βλ. σελίδα 17)

Varnostna opozorila

-  Otroci kot tudi odrasle osebe z omejenimi telesnimi, duševnimi in/ali senzoričnimi sposobnostmi ne smejo nenadzorovano uporabljati sistema za prhanje. Osebe, ki so pod vplivom alkohola ali drog, sistema za prhanje ne smejo uporabljati.
-  Pri montaži je treba nositi rokavice, da se preprečijo poškodbe zaradi zmečkanja ali urezov.
-  Éviter le contact du jet de la douchette avec les parties sensibles du corps (telles par ex. que les yeux). Veiller à respecter un écart suffisant entre la douchette et le corps
-  Prha se sme uporabljati le z namenom vzdrževanja higiene oziroma umivanja kopalnice in telesa.

Navodila za montažo

Za zagotovitev standardiziranega pretoka ročne prhe in za preprečevanje vtoka umazanije iz vodovodnega omrežja se mora uporabiti predmontiran filtrski vložek. Vtok umazanije lahko poslabša delovanje ročne prhe in/ali pripelje do poškodovanja njenih funkcionalnih delov. Za tako nastalo škodo podj. Hansgrohe ne odgovarja

Tehnični podatki

Delovni tlak: maks. 0,6 MPa
 Priporočeni delovni tlak: 0,15 - 0,4 MPa
 (1 MPa = 10 bar = 147 PSI)
 Temperatura tople vode: maks. 60 °C
 Termična dezinfekcija: maks. 70 °C / 4 min
 Proizvod je zasnovan izključno za sanitarno vodo!

Opis simbola

-  **Mere** (glejte stran 18)
-  **Diagram pretoka** (glejte stran 18)
-  **Preskusni znak** (glejte stran 18)
-  **Upravljanje** (glejte stran 17)
-  **Čiščenje** (glejte stran 20) in priložena brošura
-  **Rezervni deli** (glejte stran 17)





Συναρμολόγηση
βλ. σελίδα 17



Montaža
Glejte stran 17.



Ohutusjuhised

-  Lapsed, samuti kehaliste, vaimsete või tajupiirangutega täiskasvanud ei tohi dušisüsteemi järelvalveta kasutada. Alkoholi või narkootikumide mõju all olevad isikud ei tohi dušisüsteemi kasutada.
-  Kandke paigaldamisel muljumis- ja löikevigastuste vältimiseks kindaid.
-  Duši veejoad ei tohi kokku puutuda tundlike kehaosadega (nt silmad). Jätke duši ja keha vahele piisav vahe.
-  Dušši tohib kasutada ainult vanniskäimiseks, hügieeniks ja keha pesemiseks.





Paigaldamisjuhised

Käsiduši normaalse läbivoolu tagamiseks ja torustikust pärit mustuse vältimiseks tuleb kasutada eelmonteeritud filtrit. Mustus võib talitlust halvendada ja/või tekitada käsiduši talitlusosadel kahjustusi, mille korral Hansgrohe ei vastuta.

Tehnilised andmed

Töörõhk	maks. 0,6 MPa
Soovitatav töörõhk:	0,15 - 0,4 MPa
(1 MPa = 10 baari = 147 PSI)	
Kuuma vee temperatuur:	maks. 60°C
Termiline desinfitatsioon:	maks. 70°C / 4 min
Toode on ette nähtud eranditult joogivee jaoks!	

Drošības norādes

-  Bērni, kā arī pieaugušie ar fiziskiem, garīgiem un / vai sensoriskiem ierobežojumiem nedrīkst lietot šo dušas sistēmu bez uzraudzības. Personas, kas atrodas alkohola vai narkotisko vielu iespaidā, nedrīkst lietot šo dušas sistēmu.
-  Montāžas laikā, lai izvairītos no saspiedumiem un iegriezumiem, nepieciešams nēsāt cimdus.
-  Nepieciešams izvairīties no dušas strūkļas tieša kontakta ar jutīgām ķermeņa daļām (piem., acīm). Nepieciešams ievērot pietiekošu attālumu starp dušu un ķermeni.
-  Dušu drīkst izmantot vienīgi vannošānās, higiēnas un ķermeņa tīrīšanas nolūkiem.







Norādījumi montāžai

Iepriekš iemontētais filtra elements ir jāizmanto, lai nodrošinātu normālu plūsmu dušas sprauslās un izvairītos no nefīrumu ieplūšanas no ūdensvada. Nefīrumu ieplūšana var ietekmēt funkciju un/vai radīt bojājumus dušas sprauslas elementos, par šādiem bojājumiem Hansgrohe neatbild.

Tehniskie dati

Darba spiediens:	maks. 0,6 MPa
Ieteicamais darba spiediens:	0,15 - 0,4 MPa
(1 MPa = 10 bar = 147 PSI)	
Karstā ūdens temperatūra:	maks. 60°C
Termiskā dezinfekcija:	maks. 70°C / 4 min
Izstrādājums ir paredzēts tikai dzeramajam ūdenim!	







Sūmbolite kirjeldus

-  **Mõõtude** (vt lk 18)
-  **Läbivooludiagramm** (vt lk 18)
-  **Kontrollsertifikaat** (vt lk 18)
-  **Kasutamine** (vt lk 17)
-  **Puhastamine** (vt lk 20) ja kaasasolev brošüür
-  **Varuosad** (vt lk 17)

Paigaldamine
vt lk 17



Simbolu nozīme

-  **Izmērus** (skat. 18. lpp.)
-  **Caurplūdes diagramma** (skat. 18. lpp.)
-  **Pārbaudes zīme** (skat. 18. lpp.)
-  **Lietošana** (skat. 17. lpp.)
-  **Tīrīšana** (skat. 20. lpp.) un klāt pievienotais buklets
-  **Rezerves daļas** (skat. 17. lpp.)

Montāža
skat. 17. lpp.



! Sigurnosne napomene

- ⚠ Deca, kao i telesno, mentalno i/ili senzorno hendikepirane odrasle osobe ne smeju da koriste sistem tuša bez nadzora. Osobe koje su pod uticajem alkohola ili droga ne smeju da koriste sistem tuša.
- ⚠ Prilikom montaže se radi sprečavanja prignječenja i posekotina moraju nositi rukavice.
- ⚠ Mora se izbegavati kontakt mlaza iz tuša sa osetljivim delovima tela (npr. očima). Telo korisnika mora biti na dovoljnom odstojanju od tuša.
- ⚠ Tuš sme da se koristi samo za kupanje, tuširanje i ličnu higijenu.

Instrukcije za montažu

Mora se koncipirati predmontirani filterski uložak, kako bi se regulisao protok vode kroz ručni tuš i izbeglo prodiranje prljavštine iz vodovoda. Prljavština može dovesti do delimičnog ili potpunog oštećenja delova ručnog tuša. Za eventualna oštećenja prouzrokovana prljavštinom proizvođač Hansgrohe nije odgovoran.

Tehnički podaci

Radni pritisak: maks. 0,6 MPa
 Preporučeni radni pritisak: 0,15 - 0,4 MPa
 (1 MPa = 10 bar = 147 PSI)
 Temperatura vruće vode: maks. 60°C
 Termička dezinfekcija: maks. 70°C / 4 min
 Proizvod je koncipiran isključivo za pijaću vodu!

! Sikkerheshenvisninger

- ⚠ Barn og voksne med fysiske og psykiske og/eller sensoriske handicap skal ikke bruke dusjsystemet uten oppsyn. Personer som er påvirket av alkohol eller narkotika skal ikke bruke dusjsystemet.
- ⚠ Bruk hansker under montasjonen for å unngå klem- og kuttskader.
- ⚠ Dusjstrålen skal ikke komme i kontakt med ømfintlige kroppsdeler (f.eks. øynene). Overhold en tilstrekkelig avstand mellom dusjen og kroppen.
- ⚠ Dusjen skal kun brukes for bading, til hygieneformål og til kroppsrengjøring

Montagehenvisninger

Den forhåndsmonterte filterinnsatsen skal brukes for å garantere hånddusjens standardgjennomstrømning og for å forhindre smussinnspylinger fra ledningsnettet. Smussinnspylinger kan påvirke funksjonen negativt og/eller føre til skader på hånddusjens funksjonsdeler. Hansgrohe påtar seg inget ansvar for skader som resulteres av dette.

Tekniske data

Driftstrykk: maks. 0,6 MPa
 Anbefalt driftstrykk: 0,15 - 0,4 MPa
 (1 MPa = 10 bar = 147 PSI)
 Varmtvannstemperatur: maks. 60°C
 Termisk desinfisering: maks. 70°C / 4 min
 Produktet er utelukkende designet for drikkevann!

Opis simbola



Mere (vidi stranu 18)



Dijagram protoka (vidi stranu 18)



Ispitni znak (vidi stranu 18)



Rukovanje (vidi stranu 17)



Čišćenje (vidi stranu 20) i priložena brošura



Rezervni delovi (vidi stranu 17)

Symbolbeskrivelse



Mål (se side 18)



Gjennomstrømningsdiagram
(se side 18)



Prøvermerke (se side 18)



Betjening (se side 17)



Rengjøring (se side 20) og vedlagt brosjyre



Service-deler (se side 17)





Montaža
vidi stranu 17



Montasje
se side 17



Указания за безопасност

-  Не е позволено деца, както и възрастни с физически, умствени и / или сензорни ограничения да използват системата на душа без надзор. Не е позволено използването на системата на душа от лица, употребили алкохол или дрога.
-  При монтажа трябва да се носят ръкавици, за да се избегнат наранявания поради притискане или порязване.
-  Трябва да се избягва контакта на струите на разпръсквателя с чувствителни части на тялото (напр. очите). Между разпръсквателя и тялото трябва да се спазва достатъчно разстояние.
-  Позволено е използването на разпръсквателя само за къпане, хигиена и цели на почистване на тялото.







Указания за монтаж

Предварително монтираната филтърна вложка трябва да се използва, за да се осигури нормалния поток към ръчния разпръсквател и да се избегне натрупване на замърсявания от водопроводната мрежа. Натрупването на замърсявания може да наруши функцията и/или да доведе до увреждания на функционалните части на ръчния разпръсквател, Hansgrohe не носи отговорност за получените се по този начин щети





Технически данни

Работно налягане: макс. 0,6 МПа
 Препоръчително работно налягане: 0,15 - 0,4 МПа
 (1 МПа = 10 bar = 147 PSI)
 Температура на горещата вода: макс. 60°C
 Термична дезинфекция: макс. 70°C / 4 мин
 Продуктът е разработен само за питейна вода!

Описание на символите

-  **Размери** (вижте стр. 18)
-  **Диаграма на потока** (вижте стр. 18)
-  **Контролен знак** (вижте стр. 18)
-  **Обслужване** (вижте стр. 17)
-  **Почистване** (вижте стр. 20) и приложена брошура
-  **Сервизни части** (вижте стр. 17)

Уdhëzime sigurie

-  Fëmijët dhe të rriturit me aftësi të kufizuara fizike, mendore dhe/ose ndijuese nuk duhet ta përdorin sistemin e dushit pa qenë nën mbikëqyrje. Personat që janë nën ndikimin e drogave ose të alkoolit nuk duhet ta përdorin sistemin e dushit.
-  Për të evituar lëndimet e pickimeve ose të prerjeve gjatë procesit të montimit duhet që të vishni doreza.
-  Kontakti i valëve të dushit me pjesët e ndjeshme të trupit (p.sh. me sytë) duhet që të shmanget. Midis dushit dhe trupit duhet që të mbahet një distancë e mjaftueshme.
-  Dushi duhet të përdoret vetëm për qëllimet e banjave, të higjienës dhe të larjes së trupit.







Udhëzime për montimin

Njësia e montuar e filtrit duhet përdorur për të garantuar një rendiment rrjedhjeje të spërkatëses së dorës në bazë të normës si dhe për të evituar thithjen e papastërtive nga rrjeti i ujësjellësit. Ndotjet mund të ndikojnë në mënyrë negative në dhe mund të dëmtojnë pjesët funksionale të spërkatëses së dorës. Shmangje nuk mban përgjegjësi për dëmet e shkaktuara në këtë mënyrë.

Të dhëna teknike

Presioni gjatë punës maks. 0,6 МПа
 Presioni i rekomanduar: 0,15 - 0,4 МПа
 (1 МПа = 10 bar = 147 PSI)
 Temperatura e ujit të ngrohtë maks. 60°C
 Dezinfectim Termik: maks. 70°C / 4 min
 Produkti është projektuar ekskluzivisht për ujë të pijshëm!

Пërshkrimi i simbolit

-  **Përmasat** (shih faqen 18)
-  **Diagrami i qarkullimit** (shih faqen 18)
-  **Shenja e kontrollit** (shih faqen 18)
-  **Përdorimi** (shih faqen 17)
-  **Pastrimi** (shih faqen 20) dhe broshura bashkëngjitur
-  **Pjesë ndërrimi** (shih faqen 17)

Монтаж
вижте стр. 17



Montimi
shih faqen 17



تنبيهات الأمان



لا يسمح لأي أطفال أو أفراد بالغير يعانون من إعاقات بدنية أو ذهنية أو حسية أو يعانون من جميع هذه الإعاقات باستخدام المنتج إلا تحت إشراف آخرين. كما أنه لا يسمح لأي شخص تحت تأثير تناول الكحول أو المخدرات باستخدام نظام الدش.



يجب إرتداء قفازات لليد أثناء التركيب لتجنب حدوث أخطار الإنحشار أو الجروح.



يجب تجنب حدوث إتصال مباشر بين الماء الخارج من رأس الدش وبين أجزاء الجسم الحساسة (مثل العينين). يجب وجود مسافة كافية بين رأس الدش والجسم.



يسمح باستخدام الدش فقط لأغراض الإستحمام، والأغراض الصحية، وتتنظيف الجسم.



تعليمات التركيب

يجب استخدام وحدة الفلتر التي تم تركيبها مسبقاً لضمان التدفق الطبيعي من الرشاش اليدوي ومن أجل تجنب تسرب الأوساخ من شبكة الأنابيب الرئيسية، حيث يمكن لتسرب الأوساخ أن يتسبب في الإضرار بوظيفة الرشاش بشكل كلي أو جزئي أو كليهما. وبالتالي فإن شركة هانز جروهه (Hansgrohe) لن تتحمل مسؤولية أية أضرار ناتجة عن ذلك.

المواصفات الفنية

ضغط التشغيل: الحد الأقصى 0,6 ميجاباسكال
 ضغط التشغيل الموصى به: 0,4 - 0,15 ميجاباسكال
 (1 ميجاباسكال = 10 بار = PSI 147)
 درجة حرارة الماء الساخن: الحد الأقصى 60°C
 تعقيم حراري: الحد الأقصى 70°C / 4 الدقيقة
 المنتج مخصص فقط لماء الشرب!

وصف الرمز

أبعاد (راجع صفحة 18)



رسم للصرف (راجع صفحة 18)



شهادة اختبار (راجع صفحة 18)



التشغيل (راجع صفحة 17)



التنظيف (راجع صفحة 20) والكتيب المرفق



قطع الغيار (راجع صفحة 17)



التركيب راجع صفحة 17



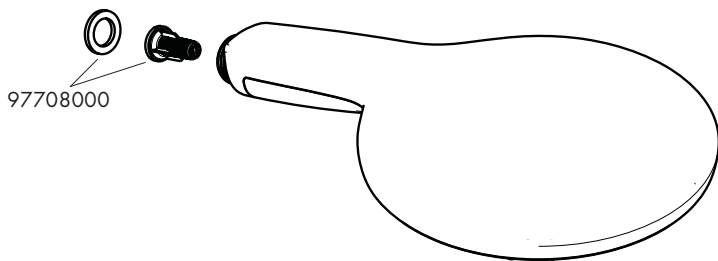
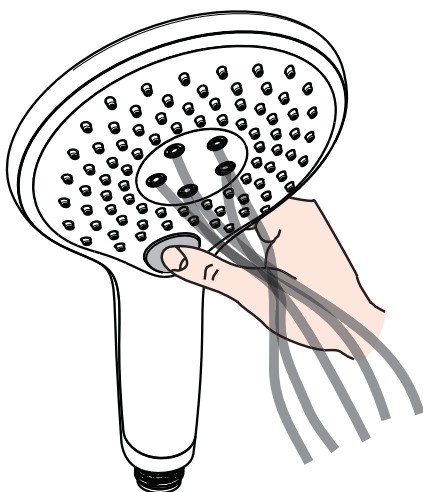
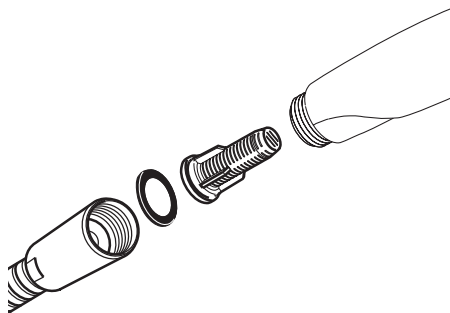



Raindance Select S 150

28587000 / 28587400

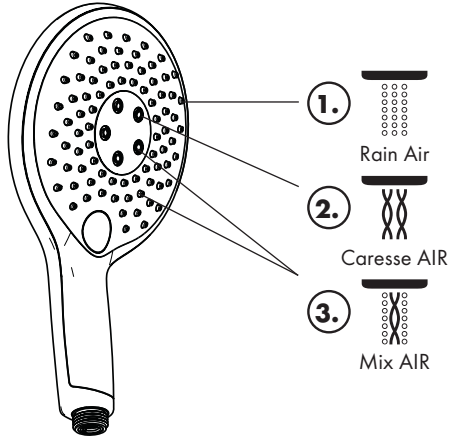
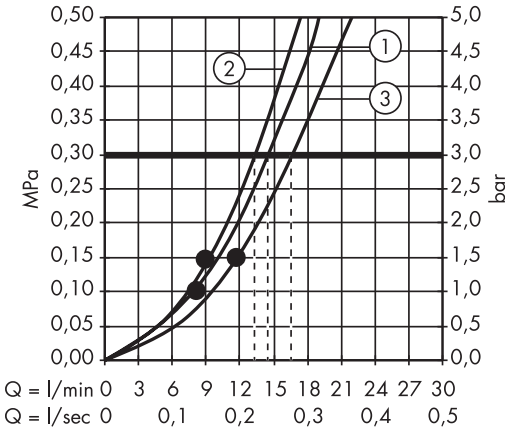
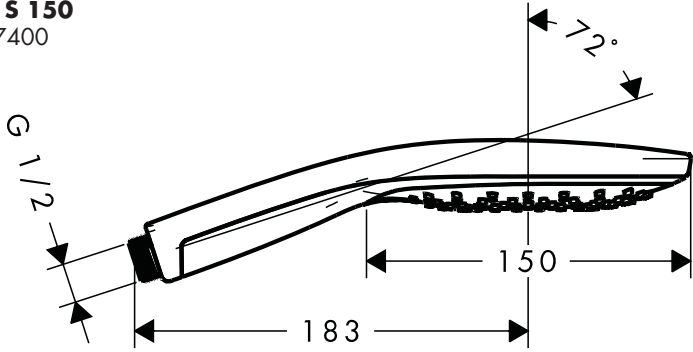

	P-IX	DVGW	SVGW	ACS	WRAS	KIWA	NF
28587XXX	P-IX 6989/IB		X	X	X	X	



Raindance Select S 120
26530000 / 26530400

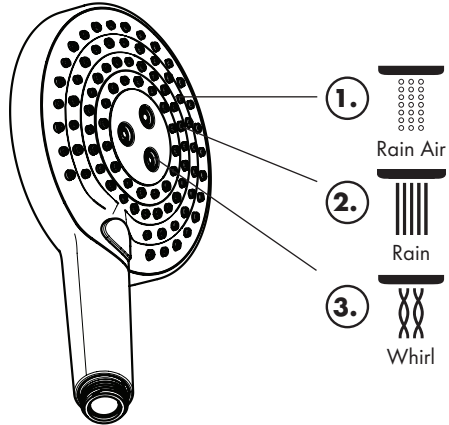
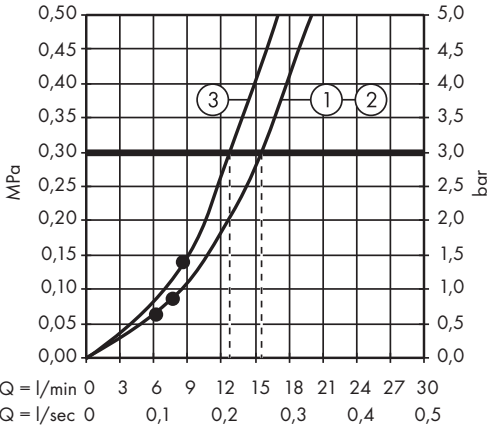
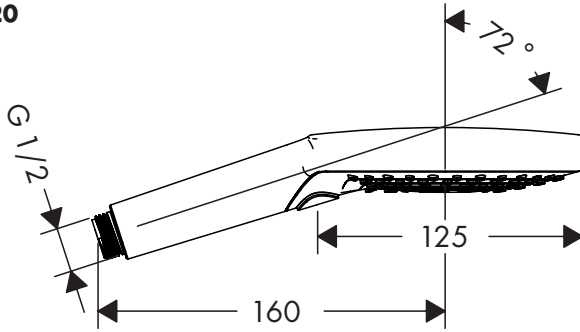

	P-IX	DVGW	SVGW	ACS	WRAS	KIWA	NF
26530XXX	P-IX28216/IB			X	X		



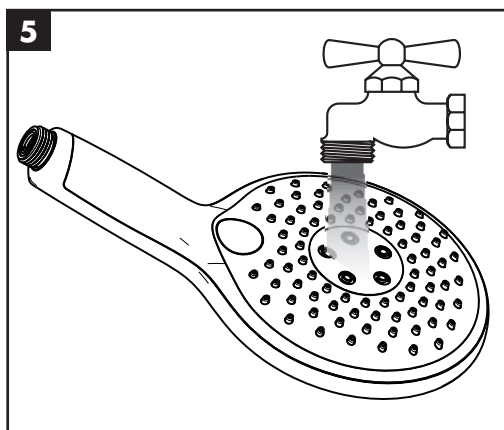
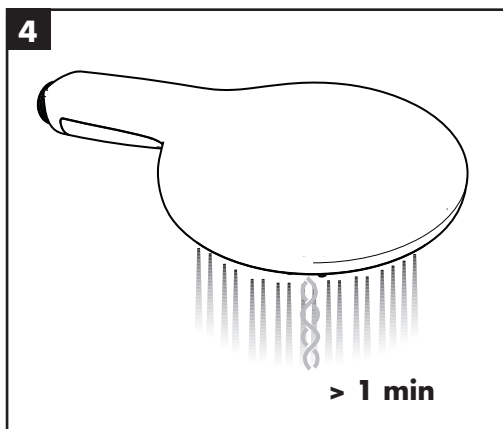
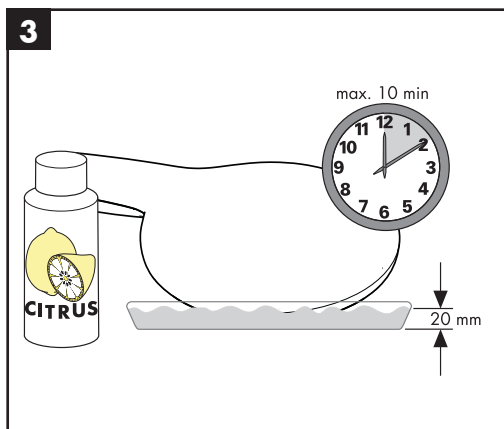
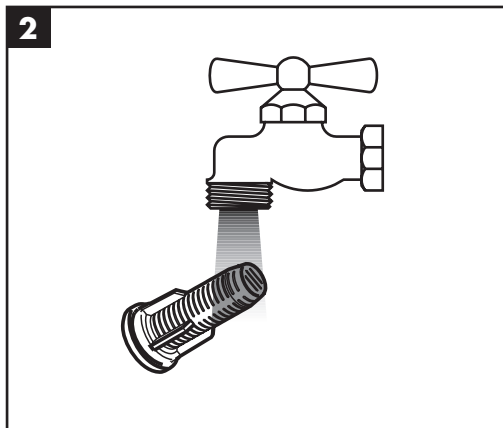
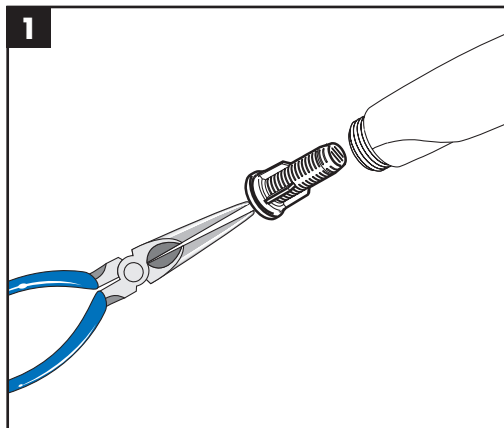



hansgrohe

Hansgrohe · AuestraÙe 5 · 9 · D-77761 Schiltach · Telefon +49 (0) 78 36/51-1282 · Telefax +49 (0) 7836/511440
E-Mail: info@hansgrohe.com · Internet: www.hansgrohe.com

02/2015
9,01654,03